

mdf italia



© COPYRIGHT 2023 MDF ITALIA SRL SOCIETA' UNIPERSONALE

2013 - 2019

MINIMA 3.0

Designed by Bruno Fattorini

Minima 3.0 by Metrica - design Bruno Fattorini.

Minima 3.0: three stands for the three key elements that compose the system: shelf, frame, cabinets. Essential and flexible, Minima 3.0 represents the natural makeover of Minima, MDF Italia collection's icon product, special mention at the XVII Compasso D'Oro ADI in 1998. Technology and innovation have enabled this thin aluminium structure, to propose an increasingly minimal yet strong identity. The storage units (with flap opening door, drawers, or open) are simply resting inside the structure and are repositionable quite easily. Uprights and shelves made of matt lacquered white and graphite grey extruded aluminium (100% recyclable). Nominal lengths of cabinets: 30, 60, 90 cm, available in a matt lacquered micro-goffered finish or in a wood variant. Two options: ground-resting (in 8 heights) or hanging (in 4 heights), always with a 33 cm depth.

Minima 3.0 evolves and renews, turning into a more versatile and adaptable furnishing system, capable of joining more functions.

The new Minima 3.0 is divided into 5 types: GROUND-RESTING, HANGING, SKETCH, SIDEBOARD AND ROOM DIVIDER. In addition, for the ground-resting version, two new heights are available - 261.5 e 298 - and new shelves with LED lights integration.

[Find out more about the sketch, sideboard and Room Divider versions.](#)

[WATCH THE VIDEO INTERVIEW WITH THE DESIGNERS](#)

STRUCTURE

Uprights and shelves made of extruded aluminium and assembled together by using a concealed joining system, capable of giving the structure stability and a special resistance to loads.

Minima 3.0 is entirely made of 100% recyclable aluminium.

MINIMA GROUND-RESTING

The wall fixing is for always suggested for heights 152 / 188.5 / 225 / 261,5 / 298 cm. The wall end frames are provided with holes for the wall fixing.

To use the system H152, H188.5, H225 (except H261,5 and H298) as a room divider for home and work environments, it is mandatory to join two structures together so as to obtain a ground depth of 66 cm to ensure a proper stability to the system.

CABINETS

The cabinets can be with open, flap opening doors or drawers. They are simply resting inside the structure and are repositionable quite easily, thus allowing to meet any storage requirements as desired and to choose your own lifestyle by using different colours, woods and shapes.

MINIMA 3.0 CABINETS

CABINETS D33 FOR MINIMA 3.0 GROUND-RESTING, HANGING, SKETCH AND ROOM DIVIDER

Open cabinet L30



L30 D33 H35 cm

Cabinet with one or two drawers L60/90



L60 D33 H35 cm

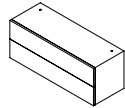

L90 D33 H35 cm



L60 D33 H16 cm
only Sketch compositions

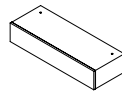

L90 D33 H16 cm
only Sketch compositions

Cabinet with flap opening door L60/90



L60 P33 H35 cm

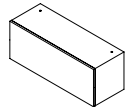

L90 P33 H35 cm

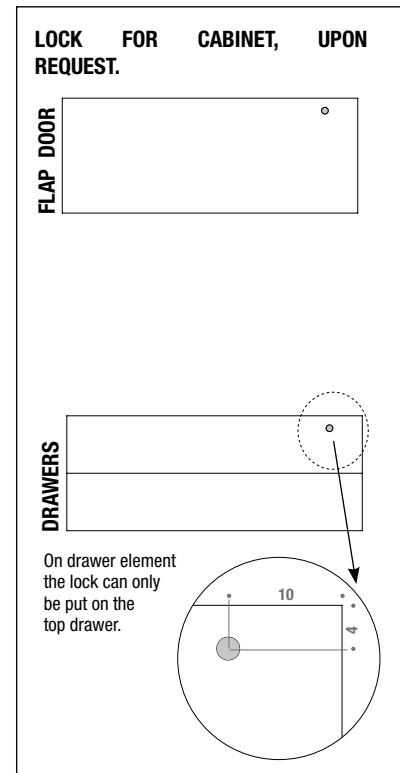

CABINETS D39 FOR MINIMA 3.0 SIDEBOARD

With flap opening door or drawers L90/120

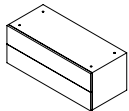

L90 D39 H35 cm

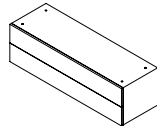

L120 D39 H35 cm

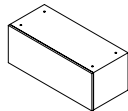

L90 D39 H35 cm

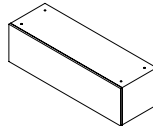

L120 D39 H35 cm

SHELVES

The shelving lengths are nominal and correspond to the inner usable space of the bookcase

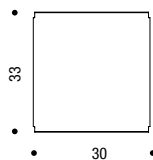

nominal size L30 cm
real size L31,5 cm

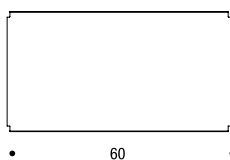

nominal size L60 cm
real size L61,5 cm



nominal size L90 cm
real size L91,5 cm



nominal size L120 cm
real size L121,5 cm

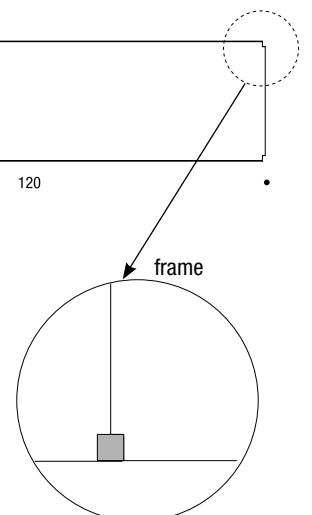

Shelf D30 for Minima 3.0 ground-resting only, NOT available with LED

NB: shelves for Sideboard composition have depth 39 cm

MINIMA 3.0 GROUND-RESTING

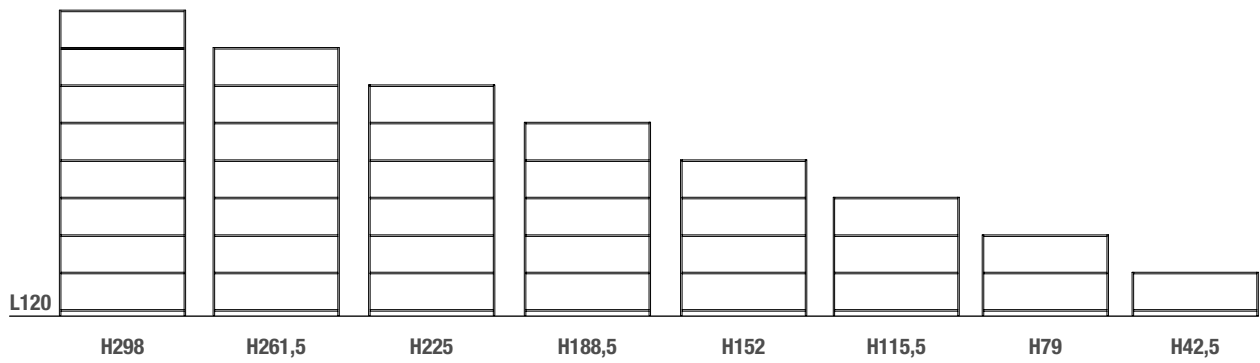
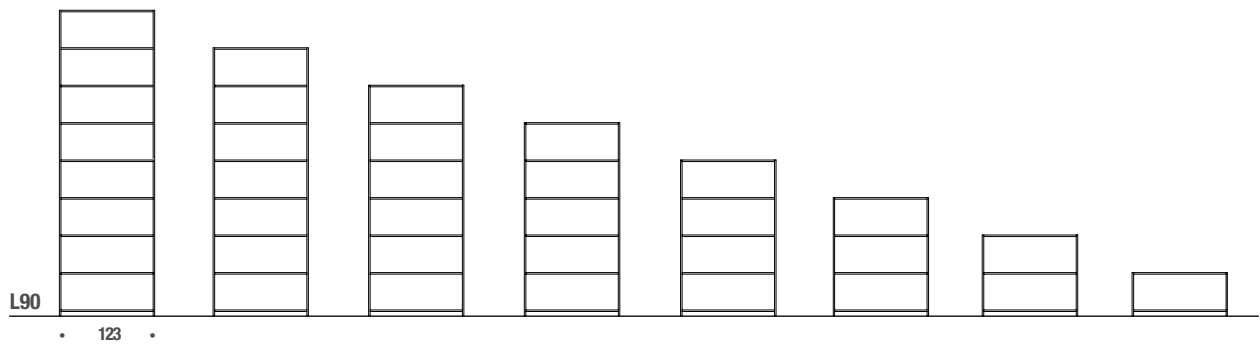
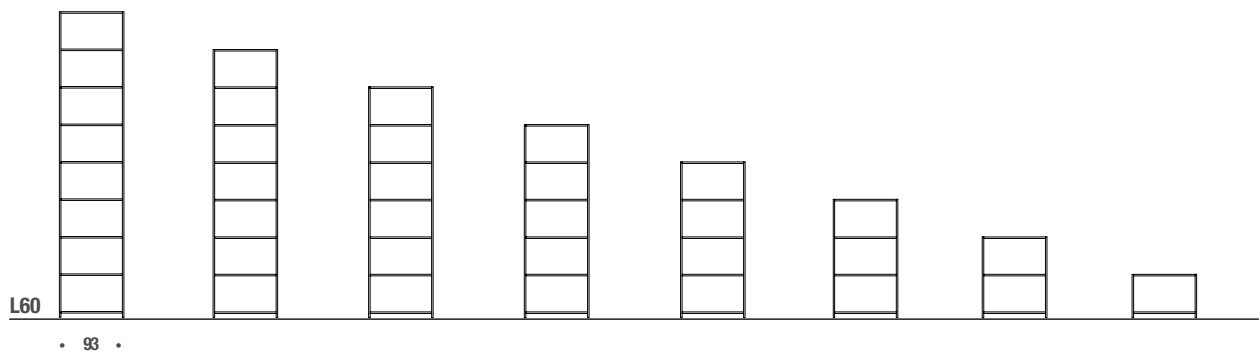
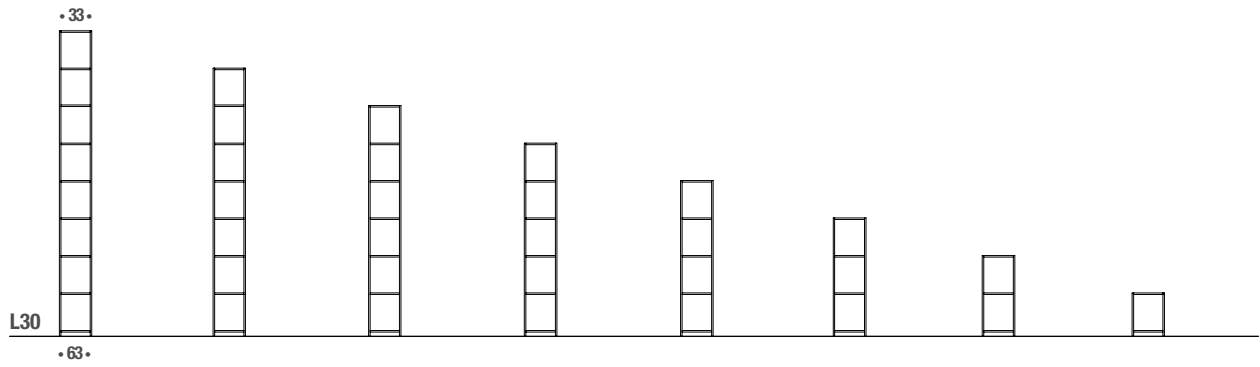

MINIMA 3.0 GROUND-RESTING

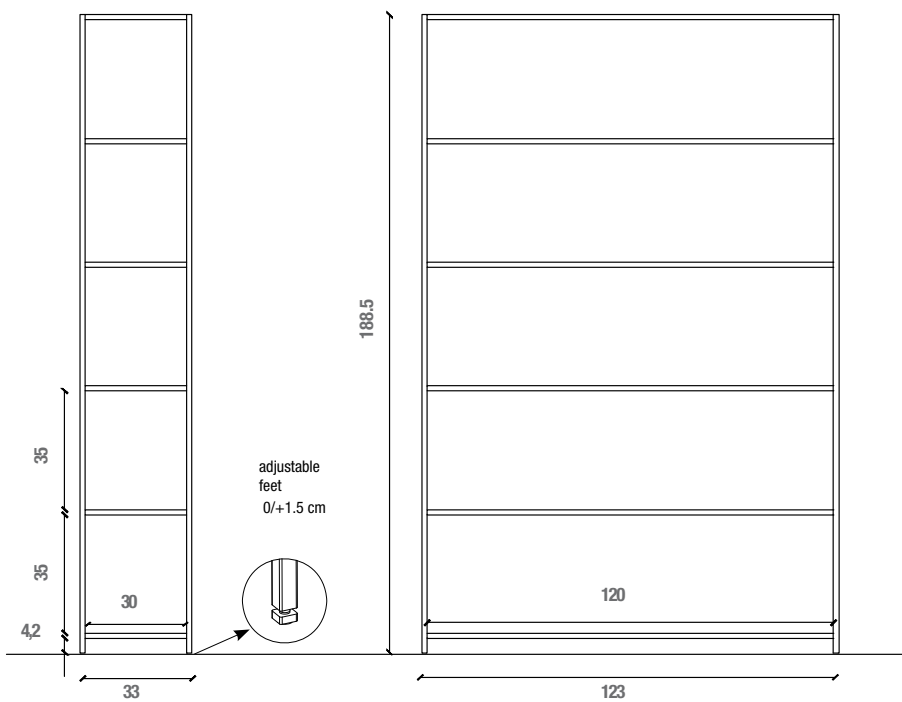
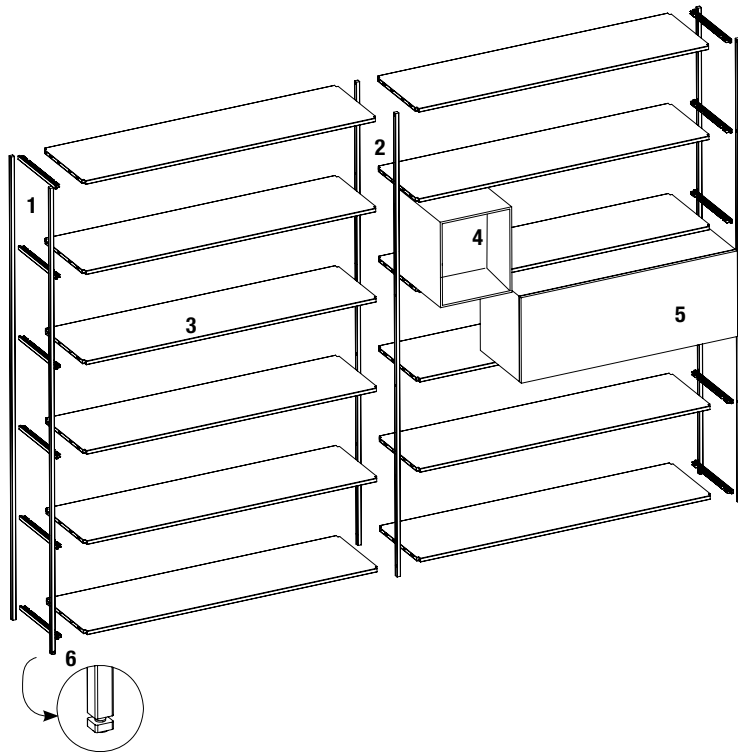

MINIMA 3.0 GROUND-RESTING

RULES FOR COMPOSITIONS WITH INTEGRATED LED

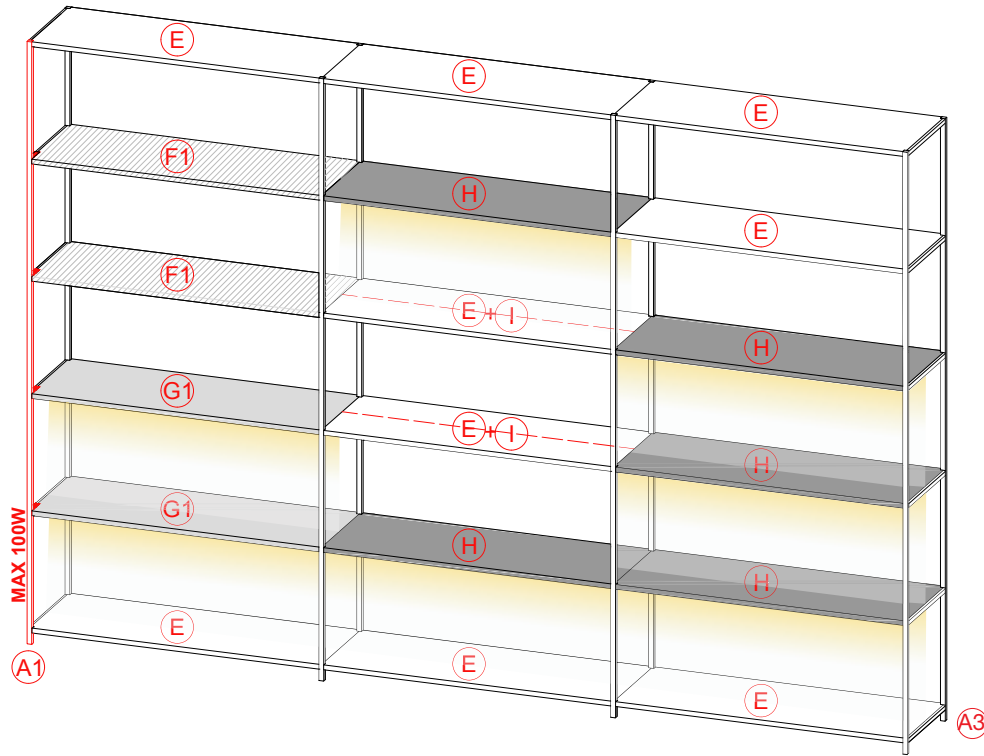

POWER FOR LED COMPOSITIONS

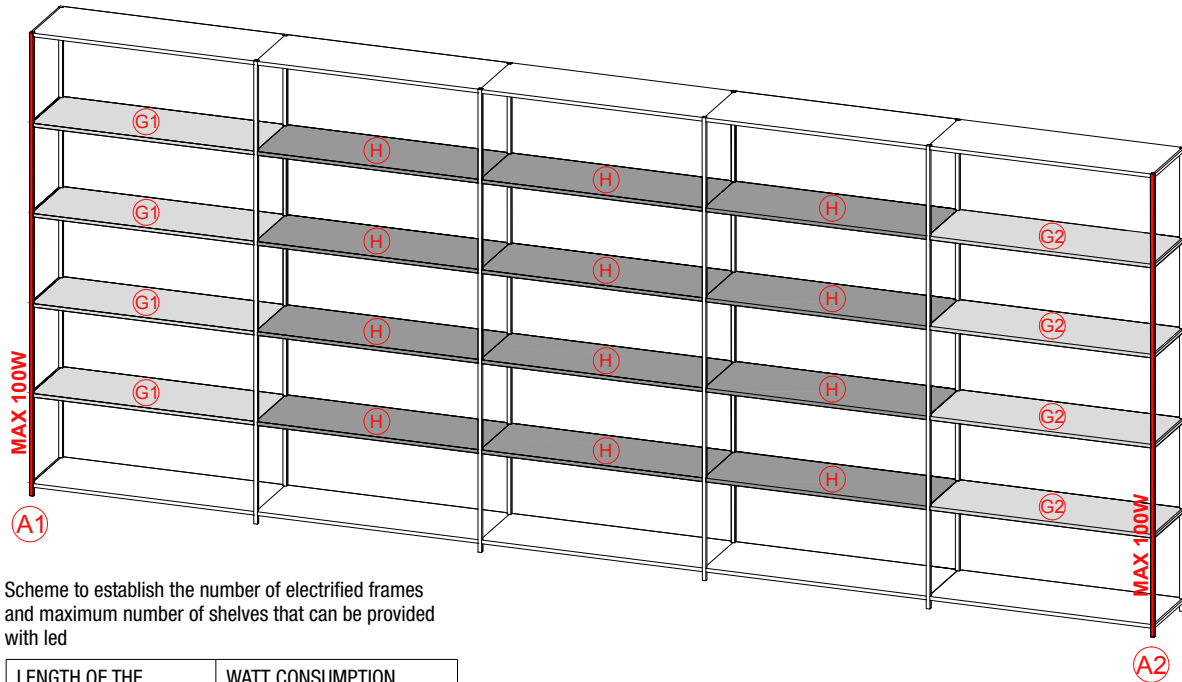

Scheme to establish the number of electrified frames and maximum number of shelves that can be provided with led

LENGTH OF THE SHELF WITH LED	WATT CONSUMPTION FOR EACH SHELF
60 cm	6,5 W
90 cm	10 W
120 cm	13,5 W

ELECTRIFIED FRAMES FOR ALL HEIGHTS 100W

IN THE ABOVE EXAMPLE: 20 SHELVES WITH LED CM 90 = 20 X 10 W = 200 W*

*maximum power limit for 2 electrified frames

MINIMA 3.0 GROUND-RESTING

SHELVES



E - STANDARD shelf



F1 - LEFT end shelf with CONNECTOR



F2 - RIGHT end shelf with CONNECTOR

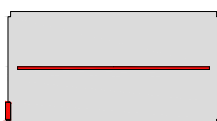

G1 - LEFT end shelf with CONNECTOR AND LIGHT

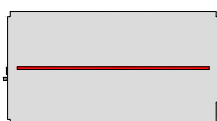

G2 - RIGHT end shelf with CONNECTOR AND LIGHT

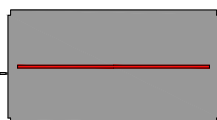

H - end/intermediate shelf with LIGHT

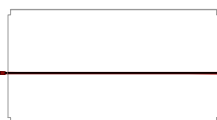

I - EXTENSION KIT

FRAMES

A1 - electrified frame left - max power 100 W

A2 - electrified frame right - max power 100 W

A3 - end frame, not electrified

Important:

- The electrified frame is always in front.
- Left SX or right DX electrified upright to be selected according to the customer needs, or to the position of the electrical outlet.
- Max 2 electrified frames per composition.
- The simultaneous use of the left SX and right DX electrified upright is necessary only if the power indicated in the scheme (100 W per upright) is exceeded.
- Max height of the frame 298 cm.
- US/EU/UK plug to be purchased according to the number of electrified frames.

D33 SHELVES

E - standard shelf

F1 - left end shelf with connector

F2 - right end shelf with connector

G1 - left end shelf with connector and light

G2 - right end shelf with connector and light

H - end/intermediate shelf with light

I - extension kit (to be inserted by the customer)

ELECTRIC SCHEME OF LEDS

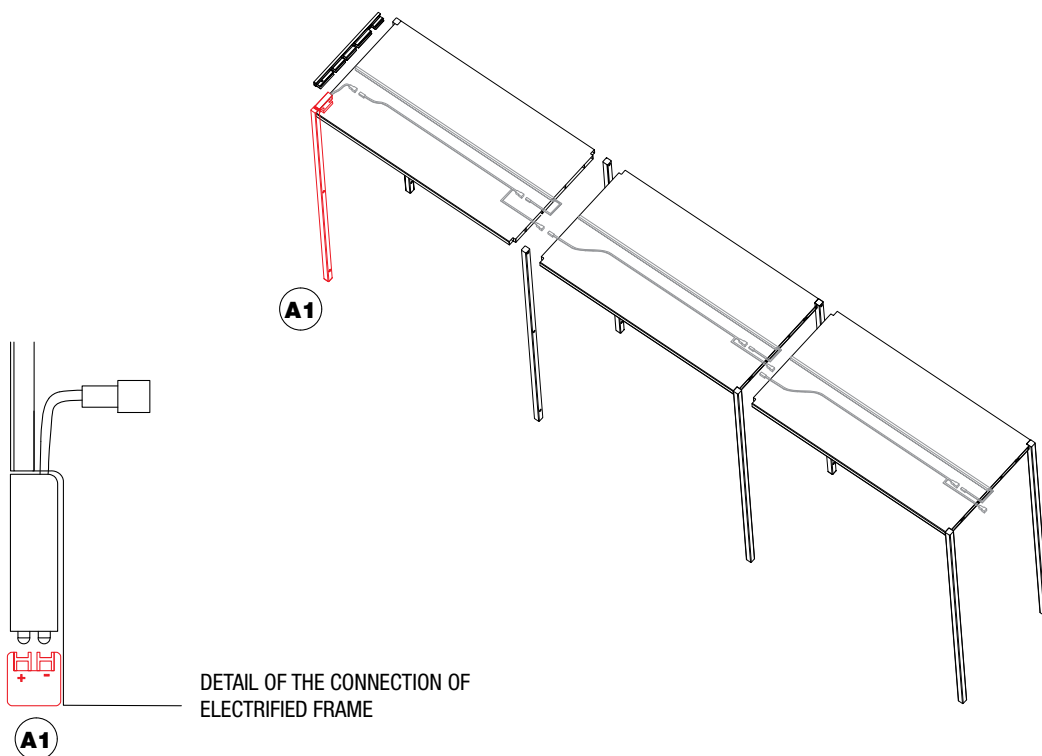

MINIMA 3.0 HANGING

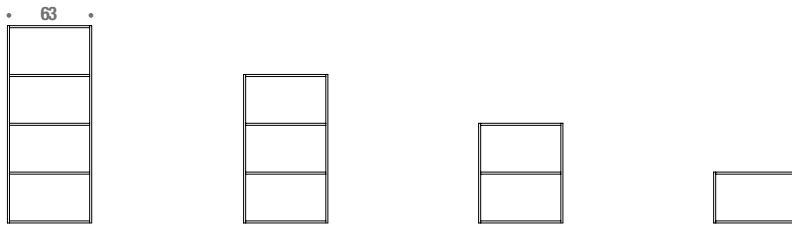

L60

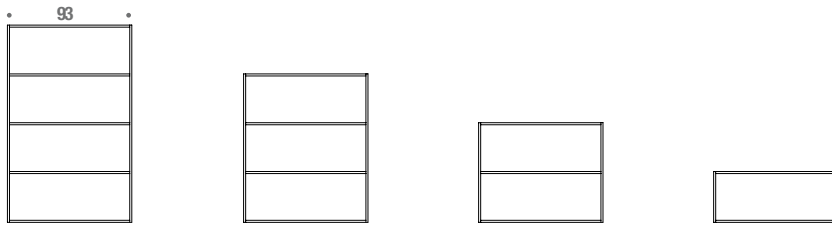

L90

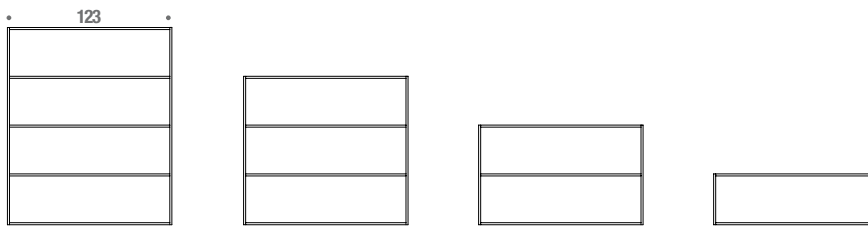

L120

H147.5

H111

H74.5

H38

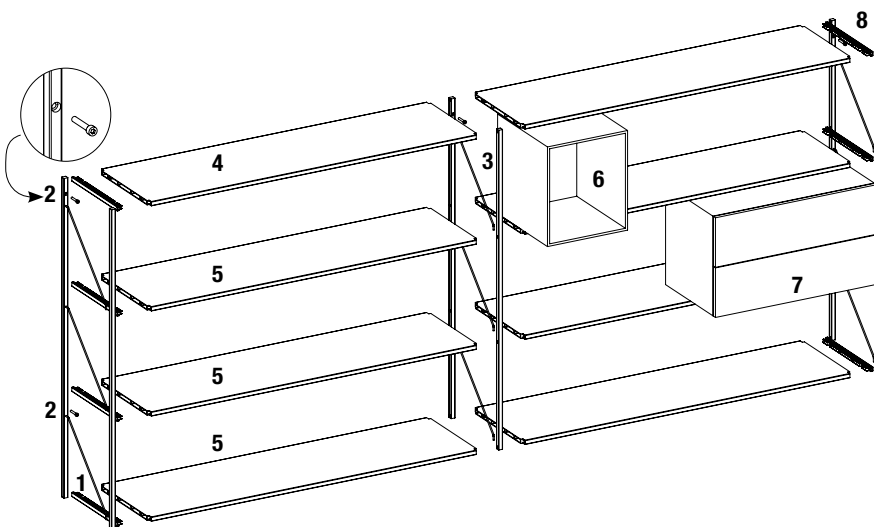

- 1 hanging end frame (L), completed with fittings and tie rods
- 2 wall-fixing
- 3 hanging intermediate frame with tie rods
- 4 top shelf
- 5 shelves (base and intermediate)
- 6 open cabinet, L30
- 7 two-drawer cabinet
- 8 hanging end frame (R), completed with fittings and tie rods

MINIMA 3.0 SKETCH

SKETCH WITHOUT MATERIAL TOP SHELF

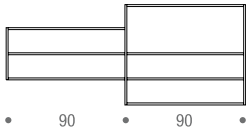

composition S-1 L185 D33 H74.5 cm

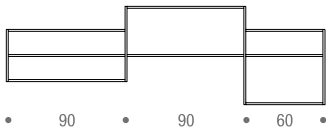

composition S-2 L246 D33 H74.5 cm

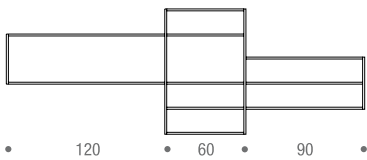

composition S-3 L276 D33 H93 cm

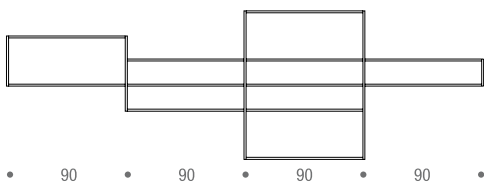

composition S-4 L368 D33 H110 cm

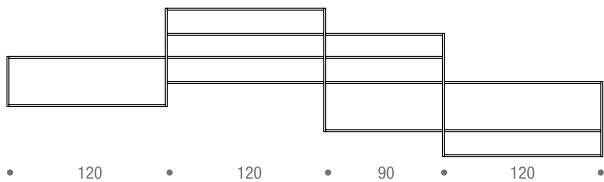

composition S-5 L458 D33 H110 cm

MINIMA 3.0 SIDEBOARD

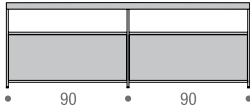

composition SB-1 L184 D39 H64 cm
2 cabinets L90 to be added (mandatory)

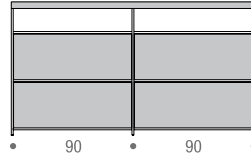

composition SB-1 L184 D39 H100 cm
4 cabinets L90 to be added (mandatory)

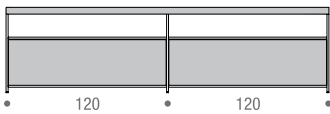

composition SB-2 L244 D39 H64 cm
2 cabinets L120 to be added (mandatory)

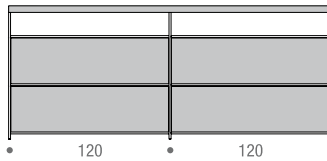

composition SB-2 L244 D39 H100 cm
4 cabinets L120 to be added (mandatory)

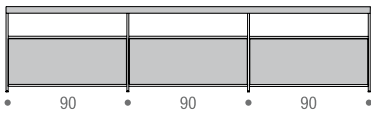

composition SB-3 L276 D39 H64 cm
3 cabinets L90 to be added (mandatory)

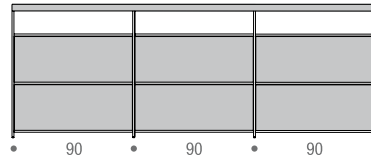

composition SB-3 L276 D39 H100 cm
6 cabinets L90 to be added (mandatory)

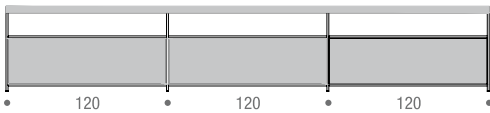

composition SB-4 L366 D39 H64 cm
3 cabinets L120 to be added (mandatory)

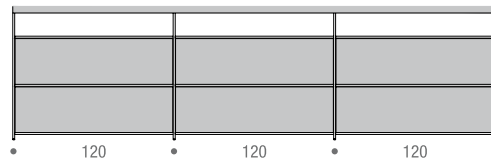

composition SB-4 L366 D39 H100 cm
6 cabinets L120 to be added (mandatory)

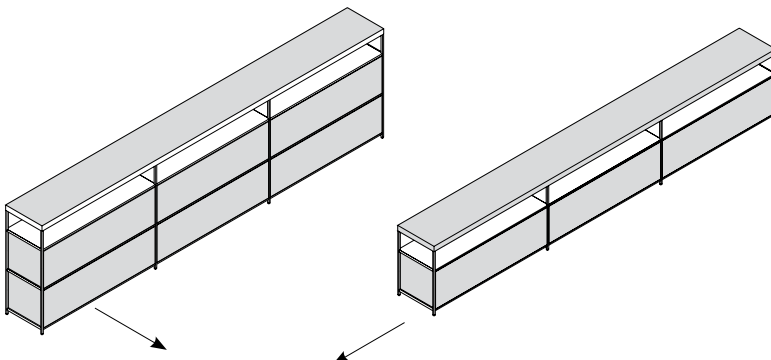

CABINETS D39 FOR MINIMA 3.0 SIDEBOARD WITH FLAP OPENING DOOR OR DRAWERS L90/120 MANDATORY TO BE ADDED

MINIMA 3.0 ROOM DIVIDER

EXAMPLE OF CONFIGURATION WITH 7 SHELVES

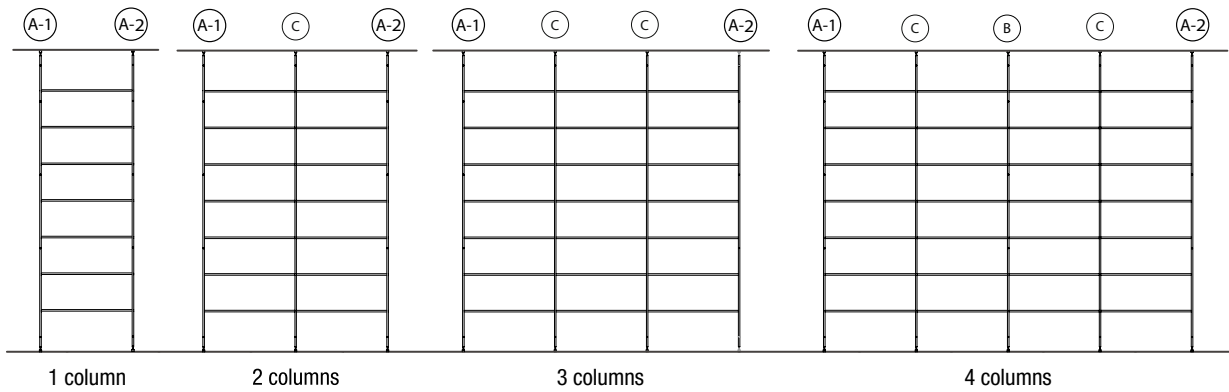

Width of the compositions and pairing of the shelves

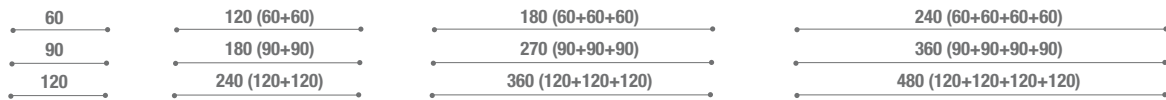

IMPORTANT: Compositions max 6 columns. Mixed compositions, eg: 60 + 90 + 60, are not allowed

LIST OF COMPONENTS OF THE END FRAME

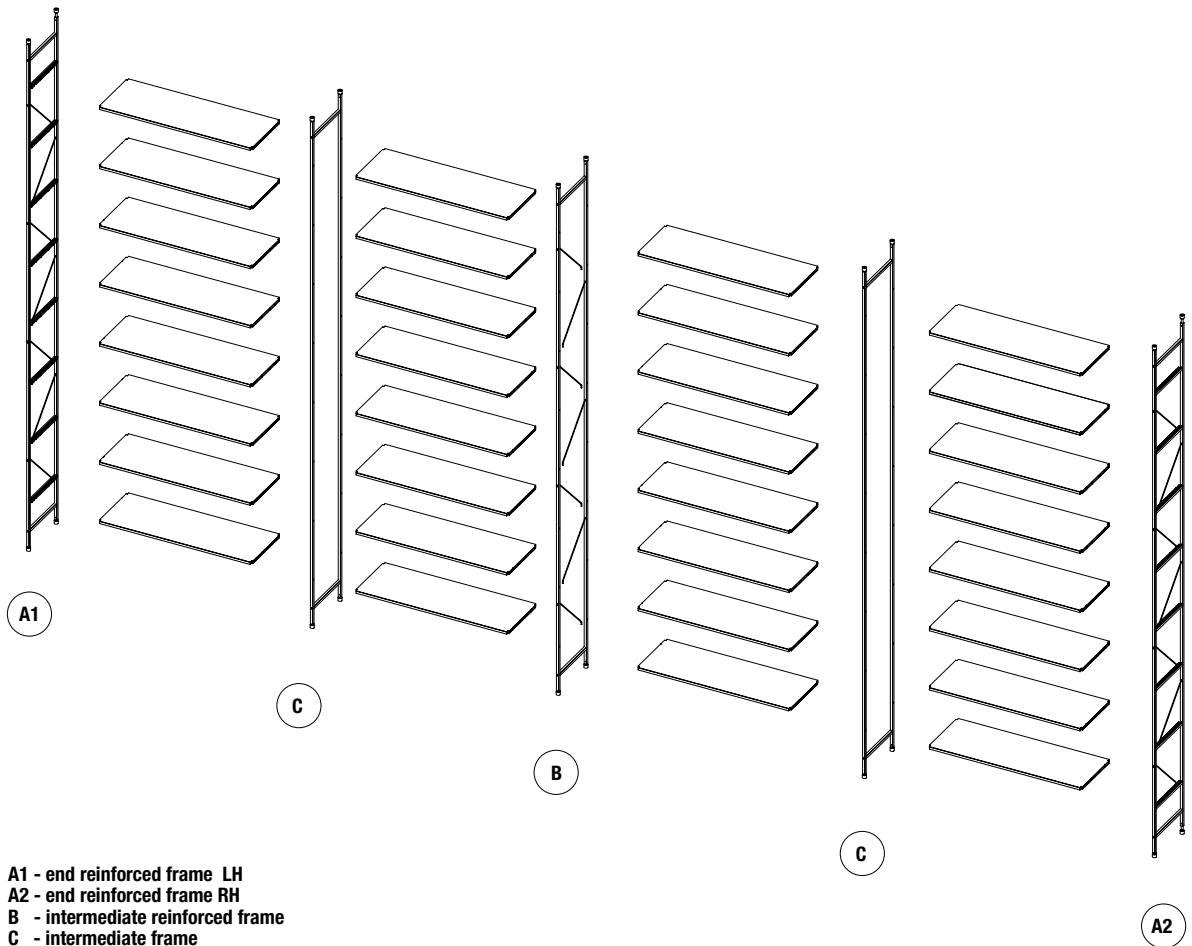

MINIMA 3.0 ROOM DIVIDER

EXAMPLE OF CONFIGURATION WITH 7 SHELVES

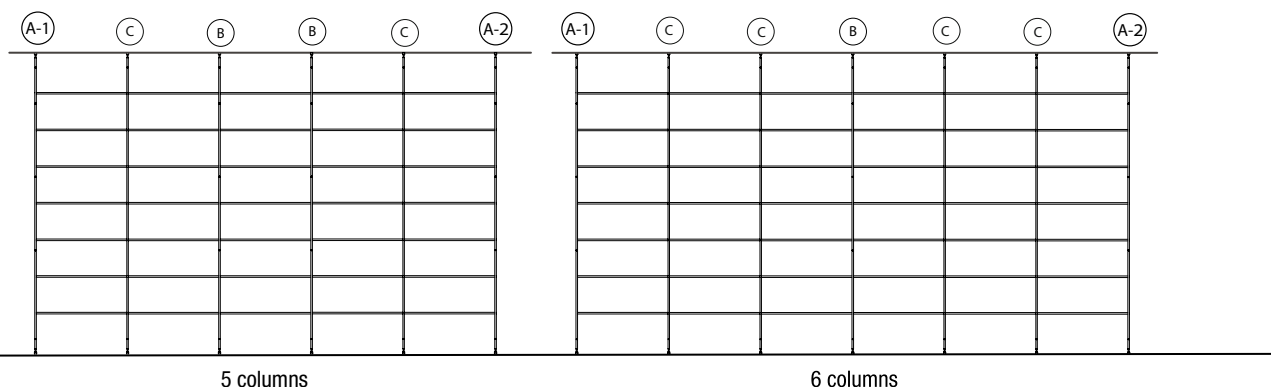

Width of the compositions and pairing of the shelves



IMPORTANT: Compositions max 6 columns. Mixed compositions, eg: 60 + 90 + 60, are not allowed

No. columns	height	A1	A2	B	C	shelf D33	hanging shelf D33	end shelf L D33	end shelf R D33
		reinforced end frame L	reinforced end frame R	reinforced intermediate frame	intermediate frame				
1 column	H250	1	1	-	-	1	5	-	-
	H260	1	1	-	-	1	5	-	-
	H270	1	1	-	-	1	6	-	-
	H280	1	1	-	-	1	6	-	-
	H290	1	1	-	-	1	6	-	-
	H300	1	1	-	-	1	6	-	-
2 columns	H250	1	1	-	1	2	-	5	5
	H260	1	1	-	1	2	-	5	5
	H270	1	1	-	1	2	-	6	6
	H280	1	1	-	1	2	-	6	6
	H290	1	1	-	1	2	-	6	6
	H300	1	1	-	1	2	-	6	6
3 columns	H250	1	1	-	2	8	-	5	5
	H260	1	1	-	2	8	-	5	5
	H270	1	1	-	2	9	-	6	6
	H280	1	1	-	2	9	-	6	6
	H290	1	1	-	2	9	-	6	6
	H300	1	1	-	2	9	-	6	6
4 columns	H250	1	1	1	2	4	-	10	10
	H260	1	1	1	2	4	-	10	10
	H270	1	1	1	2	4	-	12	12
	H280	1	1	1	2	4	-	12	12
	H290	1	1	1	2	4	-	12	12
	H300	1	1	1	2	4	-	12	12
5 campate	H250	1	1	2	2	5	5	10	10
	H260	1	1	2	2	5	5	10	10
	H270	1	1	2	2	5	6	12	12
	H280	1	1	2	2	5	6	12	12
	H290	1	1	2	2	5	6	12	12
	H300	1	1	2	2	5	6	12	12
6 campate	H250	1	1	1	4	16	-	10	10
	H260	1	1	1	4	16	-	10	10
	H270	1	1	1	4	18	-	12	12
	H280	1	1	1	4	18	-	12	12
	H290	1	1	1	4	18	-	12	12
	H300	1	1	1	4	18	-	12	12

MINIMA 3.0 ROOM DIVIDER

HEIGHTS

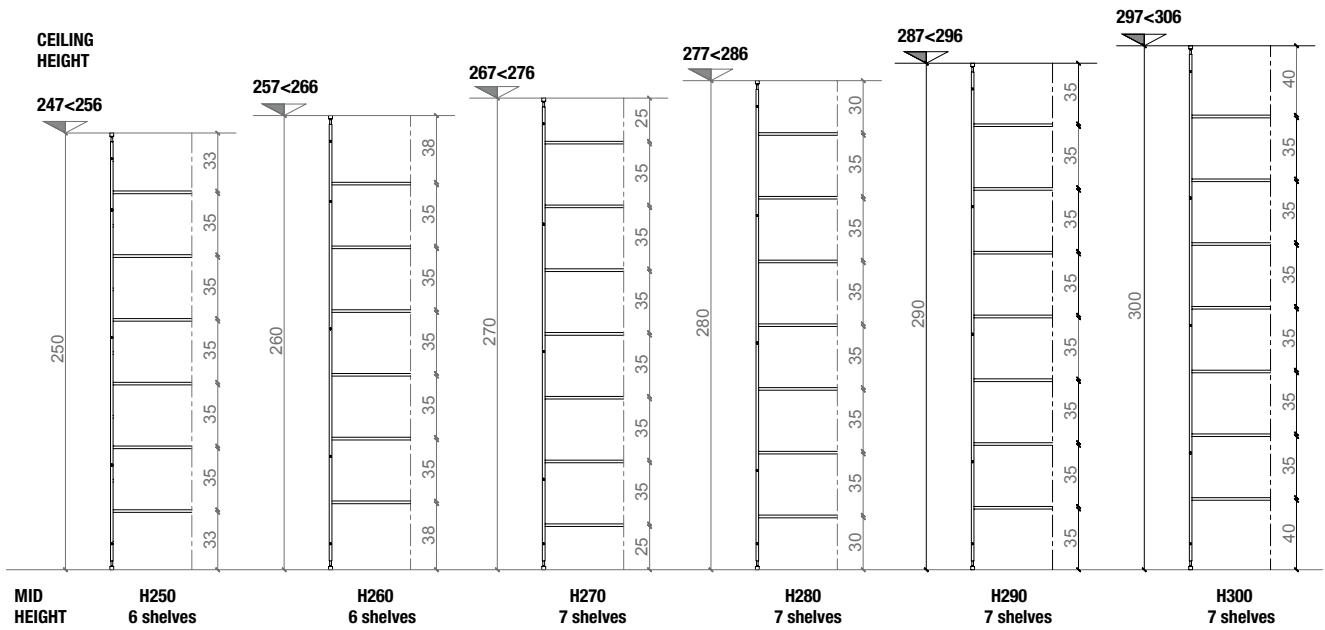

MINIMUM ADJUSTMENT

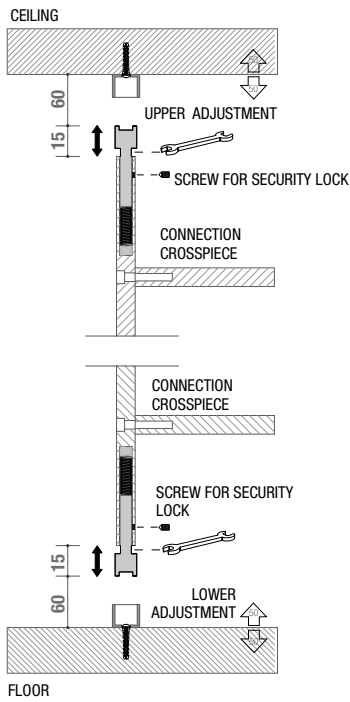

MAXIMUM ADJUSTMENT

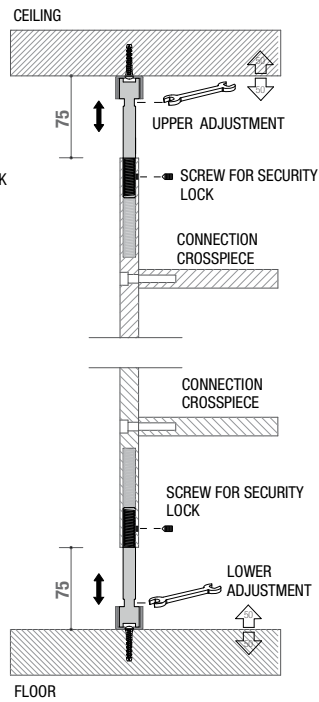

MINIMA 3.0 ROOM DIVIDER

HEIGHTS ON REQUEST

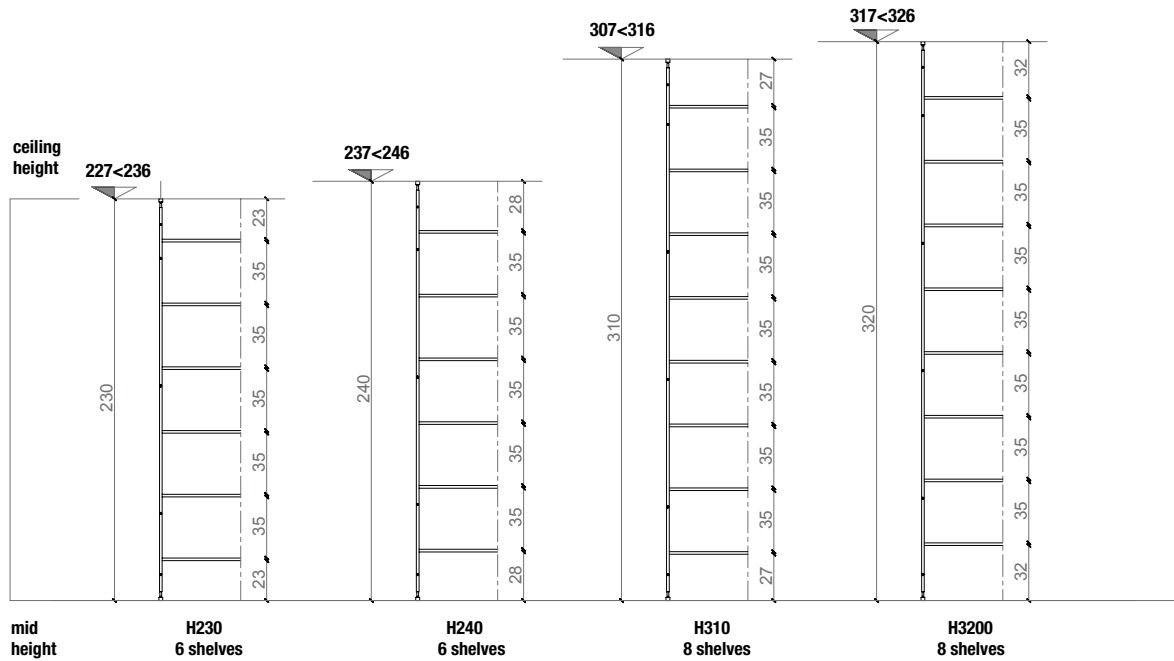

ELEMENTS NEEDED FOR CUSTOM HEIGHTS

No. columns	height	A1	A2	B	C	shelf D33	hanging shelf D33	end shelf L D33	end shelf R D33
		reinforced end frame L	reinforced end frame R	reinforced intermediate frame	intermediate frame				
1 column	H230	1	1	-	-	1	5	-	-
	H240	1	1	-	-	1	5	-	-
	H310	1	1	-	-	1	7	-	-
	H320	1	1	-	-	1	7	-	-
2 columns	H230	1	1	-	1	2	-	5	5
	H240	1	1	-	1	2	-	5	5
	H310	1	1	-	1	2	-	7	7
	H320	1	1	-	1	2	-	7	7
3 columns	H230	1	1	-	2	8	-	5	5
	H240	1	1	-	2	8	-	5	5
	H310	1	1	-	2	10	-	7	7
	H320	1	1	-	2	10	-	7	7
4 columns	H230	1	1	1	2	4	-	10	10
	H240	1	1	1	2	4	-	10	10
	H310	1	1	1	2	4	-	14	14
	H320	1	1	1	2	4	-	14	14
5 columns	H230	1	1	2	2	5	5	10	10
	H240	1	1	2	2	5	5	10	10
	H310	1	1	2	2	5	7	14	14
	H320	1	1	2	2	5	7	14	14
6 columns	H230	1	1	1	4	16	-	10	10
	H240	1	1	1	4	16	-	10	10
	H310	1	1	1	4	20	-	14	14
	H320	1	1	1	4	20	-	14	14

NB: feasibility, prices and delivery times are to be verified with our Sales Department

Finishing

The number in the dot corresponds to the number of colour/material finish.

Here below, in the section FINISH OPTIONS, please note all the colours of the materials used for this product.

SYSTEM

Structure

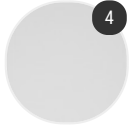

Matt painted



Material top

Cabinet



Open units



Basic flap door and drawers



Extra flap door and drawers

Finish options

STRUCTURE

Matt painted

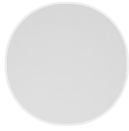

Matt painted
white X053



Matt painted
graphite grey
X054



Matt painted
shadow grey
X122



Matt painted
nickel pearl
X123

Material top



Reconstructed
marble black
ebony X111



Reconstructed
marble white
Carrara X120

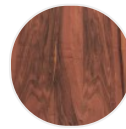

Italian walnut
(fine wood)
X119

CABINET

Open units



Fine wood,
Italian walnut
X119



Natural wood
X027



Natural grey
wood X028



Natural black
wood X029



Matt
lacquered
white X042



Matt
lacquered
shadow grey



Matt
lacquered
nickel pearl

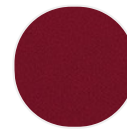

Matt
lacquered
dark red X046



Matt
lacquered
orange X047

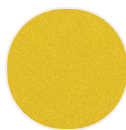

Matt
lacquered
mustard
yellow X048



Matt
lacquered
avio blue
X050



Matt
lacquered
green X049

Basic flap door and drawers



Matt
lacquered
white X042



Matt
lacquered
shadow grey



Matt
lacquered
pearl nickel



Natural black
wood X029

Extra flap door and drawers



white
grooved
Cimento X150



graphite grey
grooved
Cimento X151



shadow grey
grooved
Cimento X152



pearl nickel
grooved
Cimento X153



Lacquered
Glass White
X011



Lacquered
Glass Back
X012



Lacquered
Glass
shadow grey
X148



Lacquered
Glass pearl
nickel X149